

编号 RFL-P200
密级 _____
阶段标记 _____
页数 28

名称 RFL-P200
脉冲光纤激光器英文使用说明书

会签

单位 第二事业部
编写 李科
校对 朱军
审核 施建宏
标审 李其军
批准 黄保

武汉锐科光纤激光技术股份有限公司

Ytterbium Pulsed Fiber Laser

User's Guide

RFL-P200



CONTENTS

1 Safety Information	1
1.1 Symbols Used in this User Guide	1
1.2 Laser Classification	1
1.3 Safety Labels	2
1.4 Optical Safety	3
1.5 Electrical Safety	4
1.6 Other Safety Rules	4
2 Product Description	5
2.1 Features	5
2.2 Model Configuration	5
2.3 Package Contents	6
2.4 Unpacking and Inspection	6
2.5 Operation Environment	7
2.6 Precautions for Use	7
2.7 Specifications	8
3 Installation	10
3.1 Dimensions	10
3.2 Cooling Requirements	12
3.3 Installation Procedure	14
4 Using the Product	16
4.1 Front Panel	16
4.2 Rear Panel	17
4.3 Power Connection	18
4.4 Interface Definitions	19
5 Troubleshooting and Treatment	26
6 Warranty, Return and Maintenance	27
6.1 General Warranty	27
6.2 Limitations of Warranty	27
6.3 Service and Repair	27

1 Safety Information

Thank you for choosing Raycus fiber laser. This User Guide provides important safety, operation, warranty and other information. Please read it carefully before you use this product. In order to ensure safe operation and optimal performance of the product, please follow the warnings, cautions, operating procedures and other instructions accordingly.

1.1 Symbols Used in this User Guide

	WARNING: Describes a hazard that lead to a personal injury or death.
---	---

	CAUTION: Describes a hazard that lead to a minor personal injury or product damage.
---	--

1.2 Laser Classification

This series of lasers are classified as a high power Class 4 laser instrument according to the European Community standards EN 60825-1, clause 9. This product emits invisible laser radiation at or around a wavelength of 1064 nm, and the total light power radiated from the optical output is greater than 200W. Direct or indirect exposure of this level of light intensity may cause damage to the eye or skin. Despite the radiation being invisible, the beam may cause irreversible damage to the retina and/or cornea. Appropriate and approved laser safety eyewear must be worn all the time while the laser is operational.

	<p>WARNING: You must use appropriate laser safety eyewear when operating this device. The laser safety eyewear is selected according to the range of wavelengths emitted from this product. The end user must ensure that the laser safety eyewear used protects against light emitted by the device over its entire range of wavelengths. Please check the safety labeling on the product (Figure 1) and verify that the personal protective equipment (e.g. enclosures, viewing windows or viewports, eyewear, etc.) being utilized is adequate for the output power and wavelength ranges listed on the product.</p>
--	--

1.3 Safety Labels

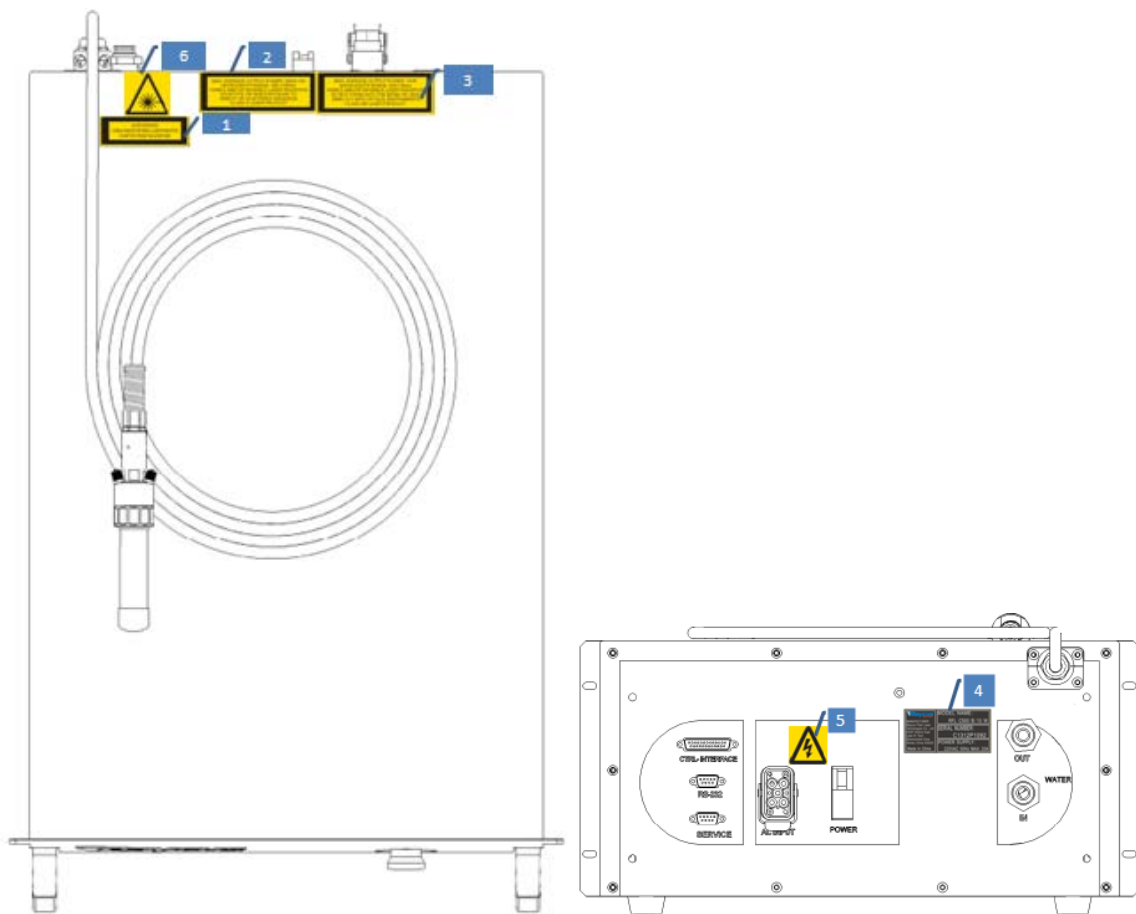







Figure 1: Safety Label Locations

Figure 1 shows safety labels and their locations. These include warning labels, apertures through which laser radiation is emitted and labels of certification and identification, etc. Specifications of these labels are as follows:

Table 1: Specifications of Safety Labels

		
<p>1.Aperture Label</p>	<p>2.Class 4 Laser Product</p>	<p>3.Class 2M Laser Product Label for Guide Laser</p>
		
<p>4. Identification Plate</p>	<p>5. Electrical Hazard</p>	<p>6.Laser Radiation Hazard</p>

1.4 Optical Safety

Any dust on the end of the collimator assembly can burn the lens and damage the laser.

	<p>CAUTION: If the output of the device is delivered through a lens with an anti-reflection coating, make sure that the lens is of good quality and clean.</p>
---	---

	<p>CAUTION: DO NOT emit when the protective cap is not removed, or the laser will be damaged.</p>
---	--

1.5 Electrical Safety

- (1) Make sure your product is grounded through the PE line of the AC power cord. The grounding must be firm and reliable.

	<p>WARNING: Any interruption from the protective earth will electrify the enclosure, which may result in personal injury.</p>
---	--

- (2) If the fuse blows out, replace it with only the same types and ratings. The use of other fuses or material is prohibited. You can contact Raycus for the information of the fuse.
- (3) Make sure that the correct voltage of the AC power source is used.

	<p>CAUTION: Failure to connect the laser to the correct voltage could damage the product.</p>
---	--

- (4) There are no operator serviceable parts inside, so do not try to remove covers, or electrical shock may be caused, and warranty will be void.

1.6 Other Safety Rules

- (1) Never look into the laser output port when power is supplied to the laser.
- (2) Avoid using the laser in a dim or darkened environment.
- (3) If this device is used in a manner not specified in this document, the protection provided by the device may be impaired and the warranty will be voided.
- (4) Do not remove the covers of the laser, or the warranty will be void. All maintenance must be performed in Raycus or by qualified Raycus personnel.

2 Product Description

2.1 Features

Raycus pulsed fiber laser is designed for industrial and scientific research applications with high pump conversion efficiency, low power consumption. It is compact and ready to use. It can be used as a stand-alone unit or easily inserted into user's apparatus.

Main Features:

- Uniform energy distribution of laser spot
- Fiber delivery
- Reliable, long lifetime
- Maintenance free operation
- High wall-plug efficiency
- Convenient control interface, same as the way of the low power pulse control
- Fast modulation

Applications:

- Cleaning
- Scientific research

2.2 Model Configuration

The model designation codes are illustrated in the following table:

Table 2: Model Names and Designation Codes

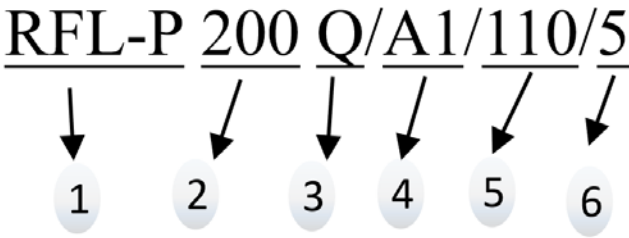
	
1	RFL-P series, Pulsed fiber laser
2	Power in W
3	Q-switched fiber laser
4	Wavelength, 'A' indicates the wavelength is 1064nm, and the wavelength of all the models in the series is 1064nm. '1' indicates the minimum pulse repetition rate is 10khz.
5	Minimum pulse duration(@20khz) is 110ns.
6	Length of delivery cable in meter

Usually we omit the suffix and present the model name as RFL-P200, RFL-P100M, etc.

However, you can find the complete model name on the identification plate.

2.3 Package Contents

Please refer to the packing list accompanying the shipment to check actual items included.

2.4 Unpacking and Inspection

Raycus fiber laser is shipped in a package designed to provide maximum protection. Upon delivery, please inspect all packaging for evidence of mishandling or damage. If you find any evidence of mishandling, please save the damaged material and contact the shipping agent and Raycus immediately.

Remove all the contents from the packing case. Take extra care when removing the unit from the packing case to ensure that the fiber optic cable is not snagged and damaged. A comprehensive packing list is included with the system documentation. Check all items against the list and

contact Raycus immediately if there is any missing item or evident damage to the unit. DO NOT attempt to install or operate the laser, if there is any evident or suspected damage to the unit.

It is recommended that you do not discard the packing materials, as they will be necessary if you ever need to ship the unit back for service at a later date.

	<p>CAUTION: The fiber optic cable and output head are precise optic instrument, ANY vibration or impact to the output head, and twist or excessive bend to the cable will damage the instrument.</p>
---	--

2.5 Operation Environment

The operation conditions are listed in the table below:

Table 3: The Operation Conditions for the Laser

Power Capacity	$\geq 1200\text{w}$
Installation Environment	Flat and no vibration
Ambient Temperature	$10^{\circ}\text{C} \sim 40^{\circ}\text{C}$
Relative Humidity	$\leq 70\%$
Weight	50kg
Water cooler	See section 3.2

It is recommended to install the product in an environment with air conditioning.

2.6 Precautions for Use

- (1) Make sure the instrument is properly grounded before you use it;
- (2) Make sure that the correct voltage of 220VAC power source is used. Failure to connect power source correctly will damage the device;
- (3) There are no user serviceable parts, equipment or assemblies inside the product. All service and maintenance shall be performed by qualified Raycus personnel. In order to prevent electric shock, please do not break the seal or uncover the shield. Failure to comply with this instruction will void the warranty;

- (4) Please inspect the output head carefully for dust or other contaminations. Use appropriate lens paper to clean it if necessary. Do not touch the output lens at any time;
- (5) Please cap the output head when it is not in use, and make sure the cap is clean;
- (6) It is not allowed to install the output head when the laser is in operation;
- (7) Do not look into the output head directly. Wear appropriate protective eye glasses all the time when operating the laser;
- (8) Failure to follow the instructions may cause malfunction and damage to the device, such damage is not covered by warranty.

2.7 Specifications

The specifications are listed in the following table

Table 4: Product Specifications

Model	Test Conditions	Indicator Value	Unit
Optical properties			
Operation Mode	Pulsed		/
Polarization State	Random		/
Nominal average output power	RR=10kHz Pmax	$100 \leq P \leq 110$	W
	RR=20kHz Pmax	$200 \leq P \leq 210$	W
	RR=30kHz Pmax	$200 \leq P \leq 210$	W
	RR=50kHz Pmax	$200 \leq P \leq 210$	W
Output Power Tunability	/	10-100	%
Center wavelength	RR=50kHz P=Pmax	1064 ± 5	nm
Spectral width	RR=50kHz P=Pmax	≤ 10	nm
Output Power Instability	After 5Hrs/RR=50kHz P=Pmax	≤ 5	%
Pulse duration	RR=10kHz P=Pmax	90-110	ns
	RR=20kHz P=Pmax	90-120	ns
	RR=30kHz P=Pmax	90-120	ns
	RR=50kHz P=Pmax	90-130	ns
Pulse setup time	RR=50kHz P=0~90% Pmax	<200	us
Pulse off time	RR=50kHz P=100%~10%Pmax	<100	us

Pulse repetition rate		10-50	kHz
Red light output power		0.1~1	mW
Optical Output Characteristics of QCS head			
Beam diameter	RR=50kHz/P=Pmax	3-5	mm
Delivery Cable Length	5		m
Electrical Characteristics			
Power Supply	AC 220V \pm 10% , 50/60Hz, Single-phase		V
Max. Power Consumption	RR=50kHz P=100% ~ 10%Pmax	1000	W
Control Mode	DB25		
Other Characteristics			
Dimensions(W×H×D)	485×237×763(inc. handles)		mm
Weight(kg)	50		kg
Operating Temperature	10~40		°C
Humidity	\leq 70		%
Storage Temperature	-20~60		°C
Cooling Method	Water Cooling		/

3 Installation

3.1 Dimensions

Figure 2, Figure 3 and Figure 4 shows dimensions of the product.

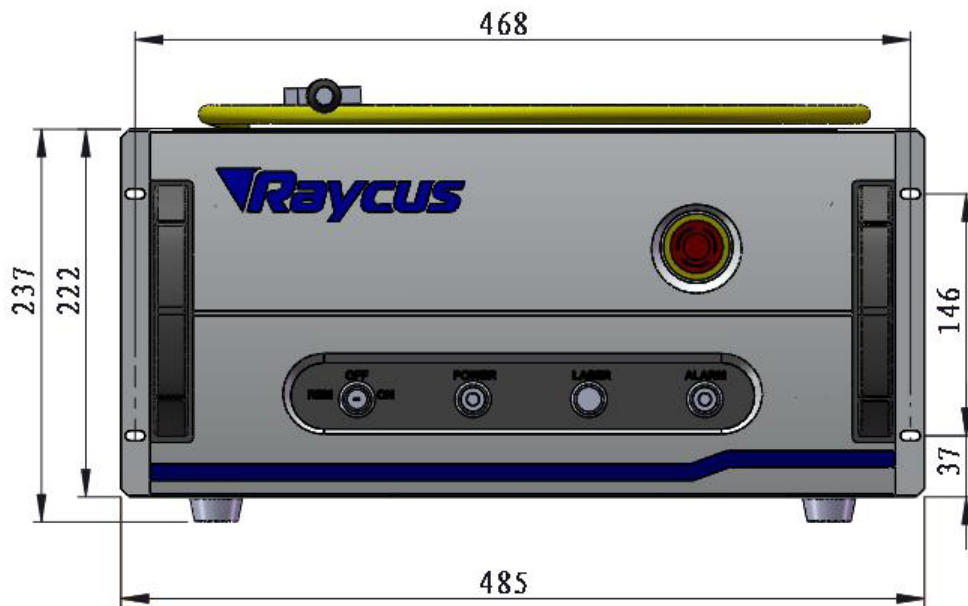

Figure 2: Front view (unit: mm)

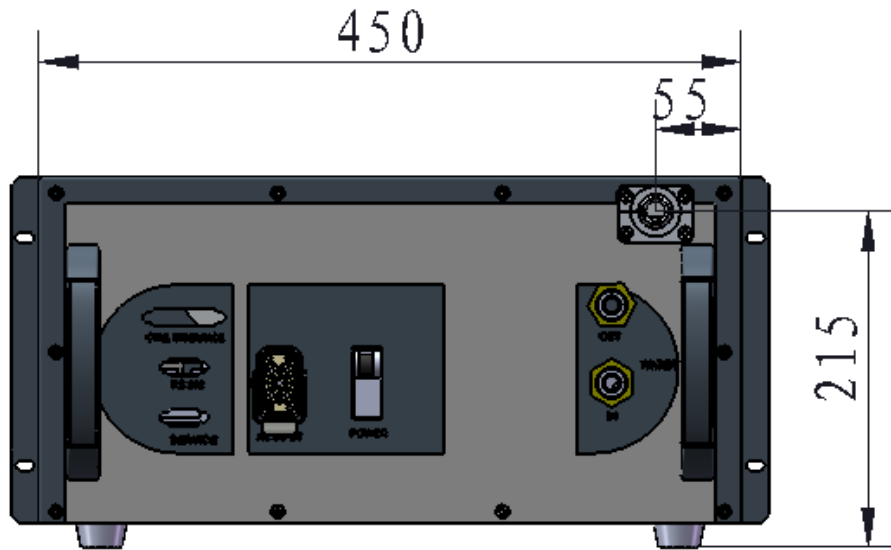

Figure 3: Rear view (unit: mm)

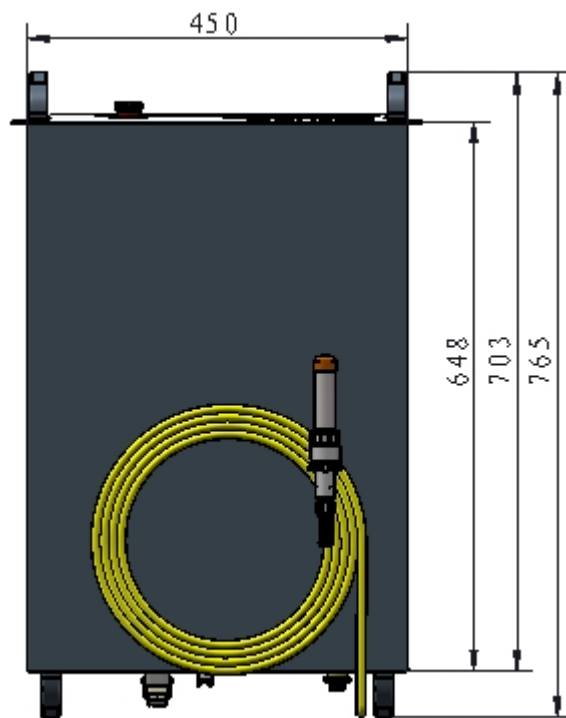

Figure 4: Top and Side view (unit: mm)

The output head is QCS style, the following figure shows the details of QCS output head.

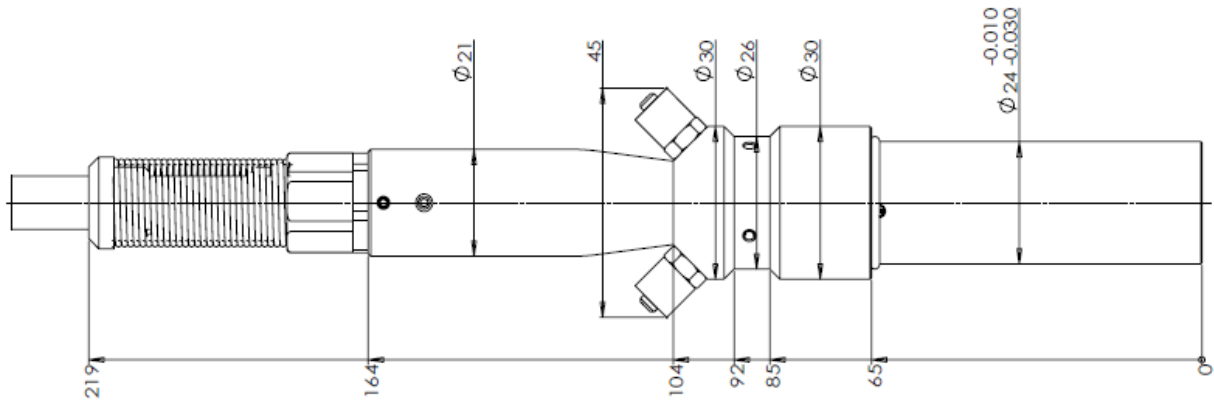

Figure 5: QCS Output head (unit: mm)

	<p>CAUTION:</p> <p>Inspect the aperture before install the output head to the processing head. Clean the aperture if necessary.</p> <p>It is strictly prohibited to disassemble the output head for Non-Raycus Personnel, or the warranty is void.</p>
--	---

3.2 Cooling Requirements

Table 5: Cooling Requirements

Parameter	Unit	200W
Cooling Capability	W	>1000
Minimum Flow	L/min	4
Maximum Pressure	Bar	8
Pipe Outside Diameter	mm	10

	<p>CAUTION:</p> <p>The water pressure to the QCS output head must be less than 2bar, or the head will be damaged. Such damage is not covered by guarantee.</p>
--	---

Water temperature setting:

Summer (ambient temperature higher than 30°C) $29 \pm 1^\circ\text{C}$;

Winter (ambient temperature lower than 30°C) $25 \pm 1^\circ\text{C}$

Requirements on Cooling Water:

Purified water should be used. In order to prevent mould growing that may lead to pipe blockage, we recommend to add alcohol about 10% of the total volume. The cooling system should be equipped with filter. Check and clean the filter every six months.

If the product is used in an environment that ambient temperature is between -10°C and 0°C , we recommend to use 30% alcohol(volume ratio), and replace it every 2 months.

If the product is used in an environment that ambient temperature is below -10°C , you must use chiller with both heating and cooling functions, and keep it in full-time operation.

Other requirements:

Before you start the laser, ensure that the supply and return connections are correct, and confirm that there is no leakage in all the water circuits. Any abnormal condition in the water circuits may cause a failure to the operation of the laser.

If you will not use the laser for a long time, water must be emptied from the product, and then both the inlet and outlet must be blocked with the nuts we provide. Failure to do so may lead to permanent equipment damage.





CAUTION: Please set the water temperature in strict accordance with the requirements above. Too low temperature may lead to condensation on the laser module and the output head. This can cause serious damage to the equipment.

	<p>CAUTION: The cooling system should be turned on first. Check any water leakage and make sure that the water temperature reaches the set point before you start the laser(Summer: $29 \pm 1^{\circ} \text{C}$; Winter: $25 \pm 1^{\circ} \text{C}$).</p>
---	---

3.3 Installation Procedure

- (1) Check if the power supply has the correct voltage (Single-phase 220VAC \pm 10%, 50/60Hz), and the earth line is connected, make sure it is firm and reliable;
- (2) Place the product in an appropriate position, immobilize it if necessary;
- (3) Connect the power cable and control cable to the product when power supply is OFF;
- (4) Insert the water pipes into the inlet and outlet;
- (5) Check the output head and clean it if necessary. This procedure must be performed by Raycus personnel or person authorized by Raycus. Make sure the environment is clean, or the output head may be contaminated. It is prohibited to use fan during installation, which will cause dust in the air;
- (6) Prevent the delivery cable from treading, pinching or excessive bending during installation;

	<p>CAUTION: All the cables can only be connected when power supply is off. Hot plug may damage the laser.</p>
---	--

	<p>CAUTION: Ensure that there are no fiber bends with radius less than 30cm when the product is installed. Avoid excessive twisting and tight bends during the robotic arm movements. Tight bends will damage the laser delivery system.</p>
---	---

	<p>When the product is in storage, the bending radius of the delivery cable should be more than 20cm.</p>
--	---

	<p>CAUTION: Avoid vibration and impact to output head, or it may be damaged.</p>
---	--

	<p>CAUTION: Removal of protective glass of the output head is prohibited for the user.</p>
---	--

4 Using the Product

4.1 Front Panel

Figure 6 shows the front panel.

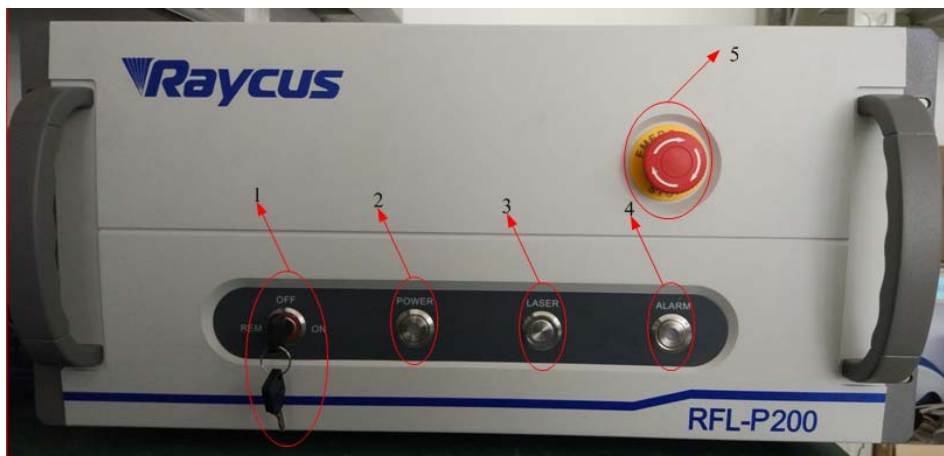

Figure 6: Front Panel View

1. **REM/OFF/ON:** Key switch, the power switch of laser control system. Insert the key (**Item 6** in Figure 6); either turn the key clockwise to the 'ON' position or counterclockwise to 'REM' position will power on the laser control system.
2. **POWER:** Power Indicator, indicates that control system of laser is switched on, when the green LED illumines.
3. **LASER:** Laser emission button, it's a button with an annular LED indicator (red color). when this button is pressed down, the main power supply of laser is ready to emit laser, and the LED illumines.
4. **ALARM:** Alarm indicator, indicates a fault condition, when the yellow LED illumines.
5. **EMERGENCY STOP:** Press it down to stop the laser immediately. Turn it clockwise to release, but the laser cannot start before it's powered on with key switch for a second time.

4.2 Rear Panel

Figure 7 shows the rear panel.

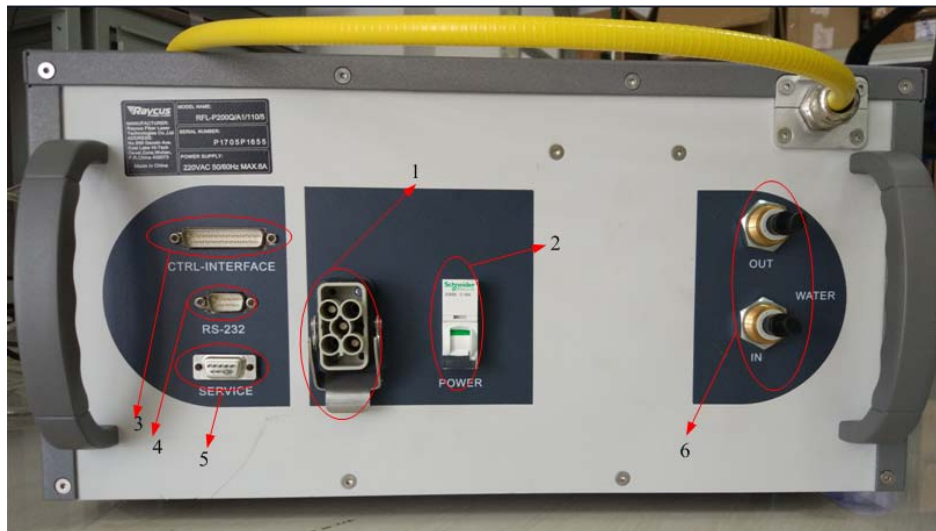



Figure 7: Rear Panel View

1. **AC INPUT:** The socket for supply input that can be only mated with the plug on the power cord we provided.
2. **POWER:** AC power switch, the main switch of the laser.
3. **CTRL-INTERFACE:** Control interface, this interface is a male DB25 connector and it's multi-functional.
4. **RS-232:** RS-232 serial port, this interface is a male DB9 connector.
5. **SERVICE:** This Service is a female DB9 connector, the definitions of the port is in section 4.4.1 .
6. **WATER:** Pipe connectors, the inlet and outlet for cooling water flow in and return, suitable for 10 mm PU pipes.

4.3 Power Connection

	<p>CAUTION: Before connect the product to AC power, you must check up that the AC supply you will apply is in accordance with the specifications provided in Table 4.</p>
---	--

A power cord is provided in the package, as in Figure 8



Figure 8: The Power Cord of the Laser

One end of the power cord is a plug, insert it in to the socket 'AC INPUT' on the rear panel.

Notice that the plug is wrong-side preventing. After insert it, lock it with the lever.

The other end of the power cord is stripped off. There are three wires labeled L, N and PE, respectively. You should connect the wires to the AC power supply according to the labels:

L-Phase Line

N-Neutral

PE-Protective Earth

4.4 Interface Definitions

4.4.1 Service

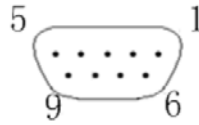

Figure 9: Definitions of the Service Port

The Service port is a female DB9 connector, as in Figure 7 and Figure 9. The definitions of the port are in the following table.

Table 6 Definitions of SERVICE

PIN NO.	DESCRIPTION	NOTE
1	Remote key switch	Same as key switch of front panel
2		
6	INTERLOCK+	PIN 6 and PIN 7 must be shorted before the product is powered
7	INTERLOCK-	
8	Remote power on	Same as power on of front panel
9		

PIN 3~ PIN 4 are of no use. PIN 6 and PIN 7 must be shorted before the product is powered. If the connection of PIN 6 and PIN 7 breaks, the laser emission will be immediately disabled. To reset the laser in normal operation, PIN 6 and PIN 7 must be shorted again, and the laser must be power off and then power on for a second time with key switch.

PIN 6 and PIN 7 are shorted in advance by Raycus.

	<p>CAUTION: The interlock pins cannot be connected to active signal, or error will be caused, or even the product may be damaged.</p>
---	---

4.4.2 Control Interface

The pin number of 'CTRL-INTERFACE' is in Figure 12:

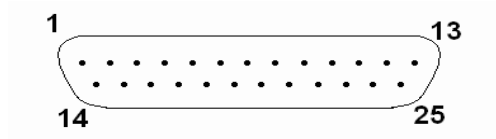

Figure 10: Pin Number of control Interface

The definitions of the control interface are as follows:

Table 7 Control Interface Definitions

PIN No.	Name	Description
1-8 (D0-D7)	Power Setting	8 bit Parallel port; D0 is minimum bit and D7 is maximum bit; Range: 0-255 (hexadecimal: 0X00-0XFF); 0 is minimum power and 255 is maximum power.
10,13-15, 24-25	Ground	Digital GND
11,12,16, 21	Laser alarms status	see alarm codes in the table below
17	VCC	+5VDC power supply input for independent operation of the guide laser and PCB
18	EE	Emission Enable (EE) signal. HIGH: Emission Enable LOW or disconnected: Emission Disable

19	EM	Emission Modulation (EM) input. HIGH (>3V): Emission ON LOW or disconnected (<1V): Emission OFF
20	Sync	Pulse Repetition Rate (Synchronization) input, square wave. (70-100kHz)/(20-200kHz)
22	Guide Laser signal	Guide Laser (red diode) ON/OFF input.
23	Obligate PIN	Reserved for Raycus only

- 1) The pump current of diode laser and the laser output power are controlled by setting the value of PIN1-PIN8 (TTL level). PIN1-PIN8 can be set from 0~255, corresponding to the laser output power from 0~100% (the actual laser power may not be strictly linear with the setting value). The relationship between PIN value and output power is shown in Table 4:

Table 8 Definition of power control PIN value

	Setting 1	Setting 2	Setting 3	Setting 4	Setting 5
PIN 1	0	0	0	0	1
PIN 2	0	0	0	0	1
PIN 3	0	0	0	0	1
PIN 4	0	0	0	0	1
PIN 5	0	0	0	1	1
PIN 6	0	0	1	1	1
PIN 7	0	1	1	1	1
PIN 8	1	1	1	1	1
Current	~50 %	~75 %	~87.5 %	~93.75 %	100%

2) Definition of alarm signal

Table 9 Definition of alarm signal

PIN12	PIN11	PIN16	PIN21	Alarm content
Reserved	Low	Low	Low	Laser temperature alarm
Reserved	High	Low	Low	Power supply error
Reserved	Low	Low	High	Normal
Reserved	High	Low	High	Laser is not ready
Reserved	Low	High	Low	High reflection alarm
Reserved	Low	High	High	System error
Reserved	High	High	Low	Reserved
Reserved	High	High	High	Reserved

- 3) PIN 17 is the external 5V input, providing power supply for alarm signal; input current must be > 20 mA.
- 4) External input signals (PIN 1-8, 18-20, 22) are all connected to the system optocoupler. The input voltage in the range of 3.3V-5V means the digital “High” , below 1.7V means “Low” . The input current must be > 7 mA.
- 5) Laser alarm output signals (PIN 16, 21) are connect to the optocoupler. External 17 pin 5V power supply should be connected to ensure the effective signal.

Caution: Before turning on PIN 19, MO signal must be switched on, or the laser may be damaged. The signal of PIN 18 must be ahead of PIN 19 at least 5 ms.

6) I/O connection of digital signal

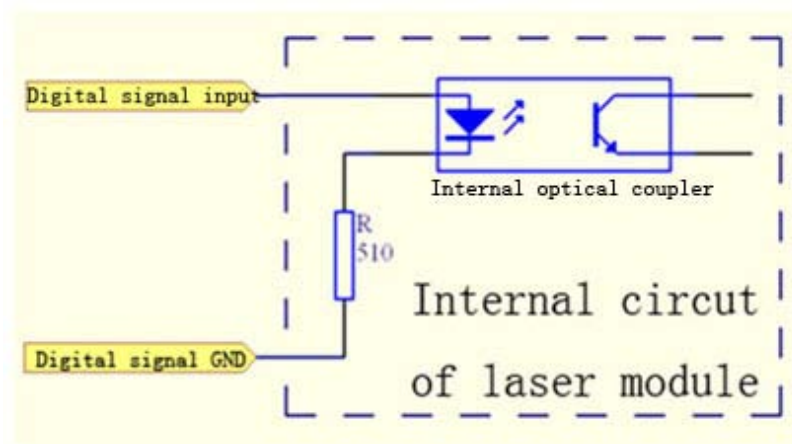

Figure 11. I/O connection of digital signal.

The input signals need at least 7 mA current. The connection circuit of input signals is shown in Figure11.

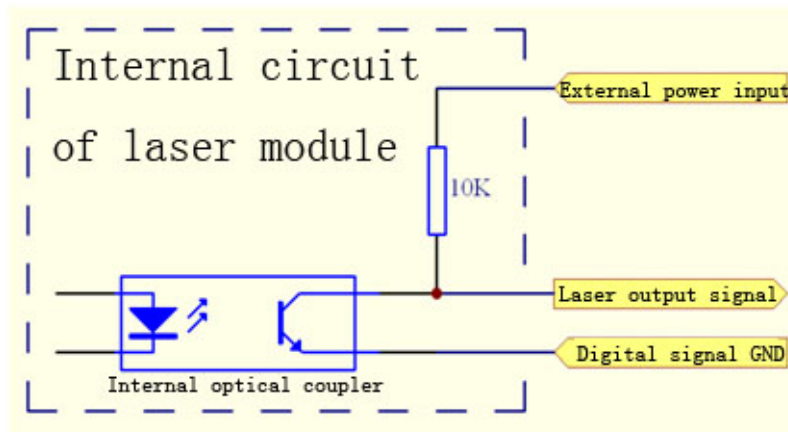

Figure 12. Schematic of output signal

4.4.3 RS-232 Serial Port

Figure 13 shows the pin number of RS-232 serial port.

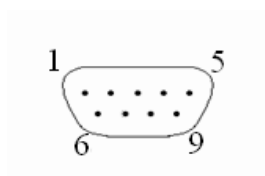

Figure 13: Pin Number of RS-232 Serial Port

And the definitions of the pins are in the following table:

Table 10 RS-232 Serial Port Definitions

PIN NO.	DESCRIPTION
2	RX
3	TX
5	GND

The other pins are of no use.

RS-232 serial port is used for Internal debugging.

4.4.4 Operation Regulations

4.4.5.1 Pre-inspection

- 1) Before you start the laser, ensure that the supply and return connections are correct, and confirm that there is no leakage in all the water circuits. Any abnormal condition in the water circuits may cause a failure to the operation of the laser(See section 3.2).
- 2) Make sure the device appearance is in good condition and the output fiber is neither excessively bended nor broken.
- 3) Please inspect the output head carefully for dust or other contaminations. Use appropriate lens paper to clean it if necessary. Do not touch the output lens at any time.
- 4) Make sure signal line of laser and cleaning system are properly connected.
- 5) Before you start the laser, Ensure that the emergency stop button is in release.

4.4.5.2 Operation procedures

1) Turn-on procedures

Connect the laser with the AC power supply, switch on the circuit breaker, then turn the key switch clockwise to the "ON" position. The Power Indicator will illumine, indicates the control system is started. Wait a few seconds and press down the "LASER" button. The illuming of the indicator on the "LASER" button reveals the power module in the laser is on.

2) Laser checking by cleaning application

For first-time testing, after the laser is started, tuning the output power gradually from 10% to 100%, check if the power is increasing by observing the reaction on the work piece. If so, the laser can be used for marking application.

4.4.5.3 Cautions

- 1) The pulse frequency should not be set beyond the range of 10~50 kHz.
- 2) The adjustment of pulse frequency during operation is prohibited.
- 3) Stop emission before you turn off the laser. The procedure should be setting the output power to 0, turning off the power supply and then turning off the chiller.

5 Troubleshooting and Treatment

If damage is suspected, please check Table 6 below.

Table 6 Troubleshooting and treatment

Symptom	Check Item, or Cause	Remedy and Reference
Alarm Indicator Illumines, and the laser submit "Temperature Error"	Is the chiller connected properly with the laser? Is the chiller in normal operation? Is the capacity of the chiller sufficient?	Refer to Chapter 3.3 carefully, for the requirements of the chiller. If all the check item is OK, the laser may be damaged.
Alarm Indicator Illumines after starting the laser, and the alarm can be reset by only restart the laser	Is the "LASER" button pressed down within 10 seconds after switching on the key switch?	The "LASER" button should be pressed down after 10 seconds, or the laser reports alarm.
The laser can not be started	Is the "Emergency Stop" released?	"Emergency Stop" must be released before you start the laser, and it is released by turning clockwise.
The laser reports "Output Power Error" or "Emission Error" during cleaning application	If the processing angle is perpendicular to the surface of the work piece?	Restart the laser, if the laser still reports error, stop further operation, and ask Raycus for help.
A decline in the processing capacity or efficiency	Is the protective glass clean?	If the protective glass is contaminated, clean it with powder free tissue before installation. If the protective glass is damaged, stop using the laser and ask Raycus for help.

If you have any question in using Raycus fiber laser, please contact us for help.

6 Warranty, Return and Maintenance

6.1 General Warranty

Raycus warrants that all Raycus fiber laser products are conformed to applicable product specifications under normal use and are free from defects in materials and workmanship. The warranties start on the date of shipment from Raycus for a period of time as set forth in the applicable purchase contracts or product specifications. Raycus has the right to choose to repair or replace any product that proves to be defective in materials and workmanship selectively during the warranty period. Only products with particular defects are under warranty. Raycus reserves the right to issue a credit note for any defective products produced in normal conditions.

6.2 Limitations of Warranty

The warranty does not cover the maintenance or reimbursement of our product of which the problem results from tampering, disassembling, misuse, accident, modification, unsuitable physical or operating environment, improper maintenance, damages due to excessive use or not following the instructions caused by those who are not from Raycus. Customer has the responsibility to understand and follow this instruction to use the device. Any damage caused by fault operating is not warranted. Accessories and fiber connectors are excluded from this warranty.

According to the warranty, client should write to us within 31days after the defect is discovered.

This warranty does not involve any other party, including specified buyer, end-user or customer and any parts, equipment or other products produced by other companies.

	<p>WARNING: It is the customer's responsibility to understand and follow operating instructions in this User Guide and specifications prior to operation-failure to do so may void this warranty. Accessories and fiber connectors are not covered by this warranty.</p>
---	---

6.3 Service and Repair

- Do not open the device. There are no user serviceable parts, equipment or assemblies for user in this product. All service and maintenance shall be performed by qualified Raycus personnel.

- Please contact Raycus as soon as possible when problems under warranty about maintenance happened to the product.
- The product returned with permission should be placed in a suitable container.
- If any damage happened to the product, please notify the carrier in document immediately.

We reserve the right to make changes in design or constructions of any of our products at any time without incurring any obligation to make changes or install the same on units previously purchased.

All the items about warranty and service above provided by Raycus are for uses' reference; formal contents about warranty and service are subject to the contract.

© Wuhan Raycus Fiber Laser technologies Co. Ltd, 2018.All Rights Reserved.